

---

Installation and Operating Instructions

# Electrostatic charging system

**iON**charge 4.0 20 kV



Translation of the original operating instructions





# Table of contents

<b>Introduction</b>	<b>5</b>
General .....	5
Versions .....	6
Application.....	6
Advantages .....	7
<b>Safety Instructions</b>	<b>9</b>
Applications / Scope of Use .....	9
Safety symbols (pictograms).....	10
During normal operation .....	11
During installation and removal.....	12
During charging bar cleaning .....	13
Grounding .....	13
In problem situations.....	13
Ozone generation .....	13
<b>User Duties</b>	<b>15</b>
General .....	15
Safety instructions.....	15
Storage, Transport and Packaging/Unpacking .....	17
User and working safety prior to commissioning .....	17
Installation and commissioning .....	18
Charging bars contamination and cleaning .....	18
<b>Mechanical Installation</b>	<b>19</b>
Determining locations for charging bars .....	19
Avoiding loss of efficiency.....	20
Mounting options.....	21
<b>Dimensions</b>	<b>23</b>
<b>Electrical Connection</b>	<b>25</b>
Connector specification.....	25
Description of the Connections .....	26
Explanation of pin functions .....	26
Use in standalone operation .....	27
Factory settings.....	27
Use of PIN1 output: for clean bar or system error .....	28
Overview of local multi-function LED: Functions .....	29
Description of LED functions.....	29
Network Operation .....	31
<b>Application information</b>	<b>33</b>
Basic layouts for charging applications.....	34
Example: Attaching to wrap .....	34

Example: Cooling roll adhesion .....	34
Example: Strand adhesion .....	35
Setting the NodeID and the high voltage .....	35

**Technical Data 37**

Electrical data .....	37
Input .....	37
Output .....	37
General .....	37
Mechanical data .....	38
Ambient conditions .....	38
Optical display/ device status/ error .....	38
Technical Service .....	39

**APPENDIX**

Drawing .....	iONcharge 4.0: 20 kV
Drawing .....	iONnet DIN Rail Distributor plate
Connection diagram .....	Stand-alone
Connection diagram .....	Supply network 24 V
Connection diagram .....	Supply network with iONnet
Connection diagram .....	BUS Network with iONmaster
Connection diagram .....	BUS Network with iONgate
Connection diagram .....	BUS Network with iONlink

# Introduction

---

## General

Electrostatic tacking/charging systems is the most efficient, contactless way of handling physical tasks for plastic films and paper, webs and sheets.

End users and machine builders who design electrostatic charging into their process don't want to go back to mechanical (no longer contactless) solutions to reach the same application tasks.

Hildebrand Technology's charging applicators are representing the most advanced and easy way of effective handling and controlling high voltage charging applications. A single charging applicator or a combination of positive negative applicators can be used for "pinning" or "tacking" together sheets and webs of film or paper.

---

## Versions

Type	Designation	ATEX labeling	Zone
IC51	iONcharge 4.0 20 kV (positive)	–	–
IC53	iONcharge 4.0 20 kV (negative)	–	–

---

## Application

Typical applications include manufacturing of stacks, binders, chill roll edge pinning on cast film lines, lamination, in-mold labeling (IML), plastic bag manufacturing, roll transfer, shrink wrapping, and many others. In the press room and in the bindery, charging applications are a part of several processes, such as ribbon tacking, chill roll tacking, inserting cards into magazines and catalogues in saddle stitchers and perfect bound lines, and catalogue stacking.

The ATEX certified version of the iONcharge-4.0 system guarantees the highest safety levels for usage in potentially explosive environments – refer to version table.

---

## Advantages

The high-voltage supply is integrated in the electrode profile and is designed for demanding industrial applications with outstanding safety standards.

- Power supply 24 VDC (20-28 VDC)
- extremely compact, stable and glass fiber-reinforced electrode profile for mounting with mounting clips or T-slot and screws
- completely encapsulated
- housing protection type IP 68
- non-contact Tungsten emitter tips
- short circuit-proof design, 30 mm pin distance
- Microprocessor-controlled with local intelligence
- High voltage adjustment on the electrode or via CAN bus connection
- Control of compound solutions via Can-Bus and iONcontrol Touch Panel
- The emitter pins are decoupled from the high voltage using resistors
- All electrical connections are fail safe, vibration-proof plugs in housing protection type IP 54.





# Safety Instructions

## ATTENTION

### Damage to the system or components

**Please read and understand the instructions fully before installing the system!**

- ▶ All installation and repair work must be performed by qualified technicians!

The iONcharge electrostatic charging systems were developed according to the latest safety requirements for industrial applications and have successfully passed the relevant safety and life tests before delivery. The systems consist of an encapsulated, glass fiber-enforced plastic electrode profile with integrated HV generator that contains resistances and emitter pins.

Follow all instructions of this manual to ensure proper function of the system and to retain your entitlement under the guarantee. Any installation or commissioning deviating from the instructions in this manual will lead to the loss of guarantee.

---

## Applications / Scope of Use

The iONcharge high performance systems for electrostatic charging are designed to the static charge of surfaces. The technology is the latest generation of electrostatic charge systems and is used in a wide range of applications with moving webs or sheets.

## ATTENTION

### Damage to the system or components

**Any use not described in this manual as well as changes to the hardware are not permitted.**

- ▶ Only original spare parts delivered by Gema Switzerland GmbH may be used for maintenance and repair of the systems!

Installation and commissioning of the system need to fulfill all local safety standards and instructions for safe use. Operators may be exposed to potentially dangerous situations if installation and use are not in accordance with the instruction manual. Persons coming in contact with the emitter pins while they are energized can be charged and may suffer from an electric shock when they come into contact with the ground. Place guards and "Danger High Voltage" warnings signs around the point of use of the bar.

## Safety symbols (pictograms)

The following contains a list of warnings with their meanings found in the Gema operating instructions. Apart from the regulations in the relevant operating instructions, the general safety precautions must also be followed .

### **DANGER**

Indicates a hazardous situation which, if not avoided, will result in death or serious injury.

### **WARNING**

Indicates a potentially hazardous situation which, if not avoided, could result in death or serious injury.

### **CAUTION**

Indicates a potentially hazardous situation which, if not avoided, could result in minor or moderate injury.

### **ATTENTION**

Indicates a potentially harmful situation which, if not avoided, the equipment or something in its surrounding may be damaged.

### **ENVIRONMENT**

Indicates a potentially harmful situation which, if not avoided, may have harmful consequences for the environment.



### **MANDATORY NOTE**

Information which must be observed.



### **NOTE**

Useful information, tips, etc.

## During normal operation

### WARNING

#### **Danger of electric shock**

Even though the charging bar is insulated and the current is limited, touching the electrodes of the emitter pins is strongly discouraged when the bar is in operation. It is possible that persons (depending on the shunt resistance) are charged to a greater or lesser extent and experience an electric shock when they make direct contact with ground.

### WARNING

#### **Danger of electric shock**

Do not disconnect any wiring of the iONcharge system, while the 24 VDC power supply is operational regardless of whether the application is operational.

### WARNING

#### **Danger of electric shock**

Keep charging bars wired to ground at all times while the system is operational regardless of whether the 24 VDC power supply is operational or not.

### WARNING

#### **Danger of electric shock**

Disable the 24 VDC supply voltage input when processing webs that contain a metal foil or metallized film. Electrostatic charging systems in some circumstances, are not beneficial and could create a safety hazard. If metallized products are processed, please contact Hildebrand Technology. An application engineer is available to assist in the assessment of whether the use of electrostatic charging equipment is suitable.



**High voltage operation (green LED lights up permanently) should only be active when it is required for the application.**

## During installation and removal

### ATTENTION

#### Damage to components

- ▶ Do not drill holes in the bar housing, and follow the wiring instruction accurately to avoid equipment damage.

### ⚠ WARNING

#### Danger of electric shock

- ▶ Do not install or remove iONcharge equipment while the machinery and/or application are operational.

### ⚠ WARNING

#### Danger of electric shock

- ▶ Always disable the 24 VDC power supply when installing or removing the iONcharge system.

### ⚠ WARNING

#### Danger of electric shock

#### Persons with a pacemaker must not touch the emitter pins!

- ▶ Pacemakers may no longer function correctly when the distance between emitter pins and chest is  $< 3.5$  cm.
- ▶ Touching the emitter pins, especially with a large surface area such as the palm of your hand, can temporarily switch a pacemaker into error mode and may result in major health risk.

### ⚠ WARNING

#### Danger of electric shock

- ▶ Keep charging bars wired to ground at all times while the system is operational regardless of whether the 24 VDC power supply is operational or not.

## During charging bar cleaning

### ⚠ WARNING

#### Danger of electric shock

- ▶ Always disable the 24 VDC power supply when cleaning the charging bars.

### ⚠ CAUTION

#### Sharp pins

## Grounding

### ⚠ WARNING

#### Danger of electric shock

- ▶ The iONcharge charging systems **MUST** be grounded.

## In problem situations

### ATTENTION

If liquid has been spilled on the bar, disable 24 VDC power immediately. Correct the problem before restarting the machine.

### ⚠ WARNING

#### Danger when using uncertified systems

**Never use iONcharge charging systems in explosive environments if they are not Ex-Certified.**

- ▶ also refer to version table
- ▶ Ex-Certified bars have an ATEX Ex label attached to the bar profile.

## Ozone generation



Ozone may be generated when the iONcharge is in use.

**This phenomenon and its concentration depends on several parameters. It is not possible to specify a common figure of the ozone concentration during usage.**

- If the ozone concentration becomes an issue at a specific workstation, on-site measurement has to be taken and adequate ventilation must be provided.



# User Duties

---

## General

This manual must be available at all times to personal/operators using this equipment.

### Safety instructions

The iONcharge system may only be installed and operated in accordance with this manual. Always follow local regulations and standards concerning repair and grounding according to relevant European regulations such as the Low Voltage and EMC directives.

#### ATTENTION

##### Damage during transport and installation

- ▶ During transportation, the iONcharge system must be protected against damage and bending.

#### ATTENTION

##### Damage to the system or components

**Please read and understand the instructions fully before installing the system!**

- ▶ All installation and repair work must be performed by qualified technicians!



##### Authorized and trained personal

- ▶ Assembly, commissioning and maintenance of the iONcharge system may only be performed by trained and qualified personnel

**⚠ WARNING****High voltage shocks**

- ▶ Always switch off the 24 VDC power supply before working on the system!
  - ▶ Use protection equipment against unauthorized restart of the power supply during this period.
  - ▶ If the iONcharge system needs to be removed from the point of use, switch off the power supply.
  - ▶ If the power plug needs to be removed, ensure **safe grounding** of the system on the ground terminal next to the bus system.
-



---

## Storage, Transport and Packaging/Unpacking

The iONcharge system must be packed in the original packaging and protected against breakage, ingress of water and humidity. Establish the ambient conditions in accordance with the technical data in this manual.

### **⚠ Caution!**

#### **Sharp pins**

The emissions pins of the charging bars are extremely sharp and can cause injury when touched. Check carefully for possible transport damage. Inform the transporting company immediately about transport damage. Also inform Gema Switzerland GmbH immediately.

Check the following carefully when unpacking:

- Quantity delivered
- Type and model according to label
- Accessories
- Correct manual

In case of incorrect deliveries or questions, please contact your local representative or Gema Switzerland GmbH. Follow local instructions for package material disposal.

---

## User and working safety prior to commissioning

### **⚠ WARNING**

#### **Danger of electric shock**

- ▶ Always ground by using the ground stud!

Prior to commissioning, ensure that the device ground is connected to the ground stud as shown in figure 1. The ground wire must have a minimum cross-section of 2.5 mm<sup>2</sup> (AWG 13).

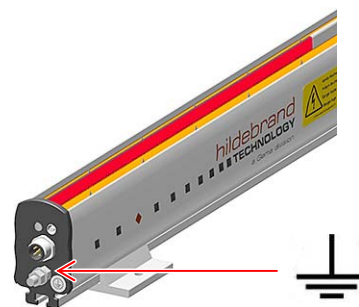

*fig. 1: Connection to machine or plant mass / ground*

The iONcharge systems for electrostatic charging must be regularly checked for mechanical damage as well as for bar contamination. Any errors must be eliminated prior to switching on the system.

---

## Installation and commissioning

The iONcharge system is an electrostatic charging system consisting of a charging bar with integrated high voltage modules and encapsulated microprocessor electronics. The charging bars are available in lengths from 320 mm to 4500 mm. The local status LED is visible on the front side and indicates the system status.

### **⚠ WARNING**

#### **Danger of electric shock**

#### **Only connect or disconnect when the power supply is OFF!**

- ▶ Ensure that the 24 VDC supply is disconnected before connecting or disconnecting the main plug.
- ▶ The device ground must always be connected.

---

## Charging bars contamination and cleaning

Contamination of the emitter pins will occur. The emitter tips of the ionizers must be kept clear of contamination and cleaned regularly.

### **⚠ WARNING**

#### **Explosion hazard**

#### **The tips of the ionizers must be kept clear of contamination and cleaned regularly.**

- ▶ Only use IPA alcohol or a suitable solvent.
- ▶ Unless the operational and local conditions specify a shorter cleaning interval, we recommend cleaning the emitter tips on a weekly basis.

### **ATTENTION**

#### **Damage to components**

#### **Use a brass brush for cleaning in order to avoid damage and scratches.**

- ▶ This should preferably have a curved handle in order to avoid injuries to the hand from the emitter pins.

# Mechanical Installation

## Determining locations for charging bars

### ⚠ WARNING

#### Explosion hazard

- ▶ If the system is installed in a potentially explosive zone, the position of the charging bar must be selected in such a way that the substrate is charged and does not pose a risk of ignition.

Attach the charging bar to the desired position, as shown in Fig. 2, for charging of web spans and other applications where the distance between the bar and the material does not vary.

Ensure that there is no ground nearby pins beside the ground needed for the charging application. Mounting bars and parts must be behind the electrode and minimum  $2 \times d$  the distance from pin to substrate as shown in Fig. 2.

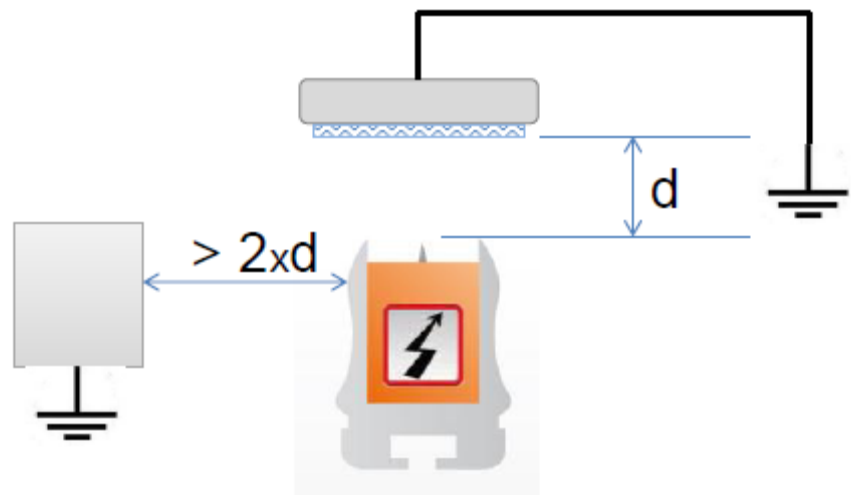

fig. 2

## Avoiding loss of efficiency

### ATTENTION

#### Ground near emission pins

- ▶ Ensure that there is no ground near the pins.

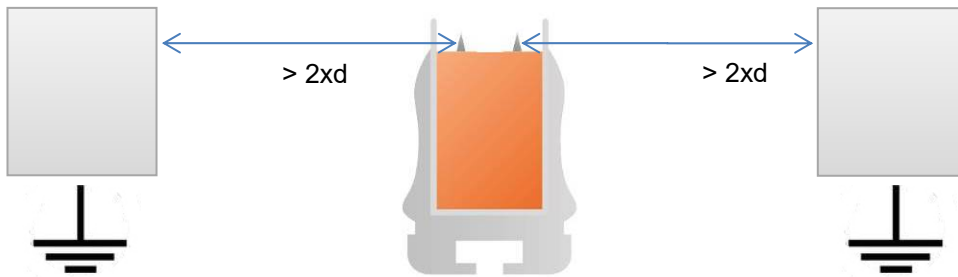

fig. 3:





# Dimensions

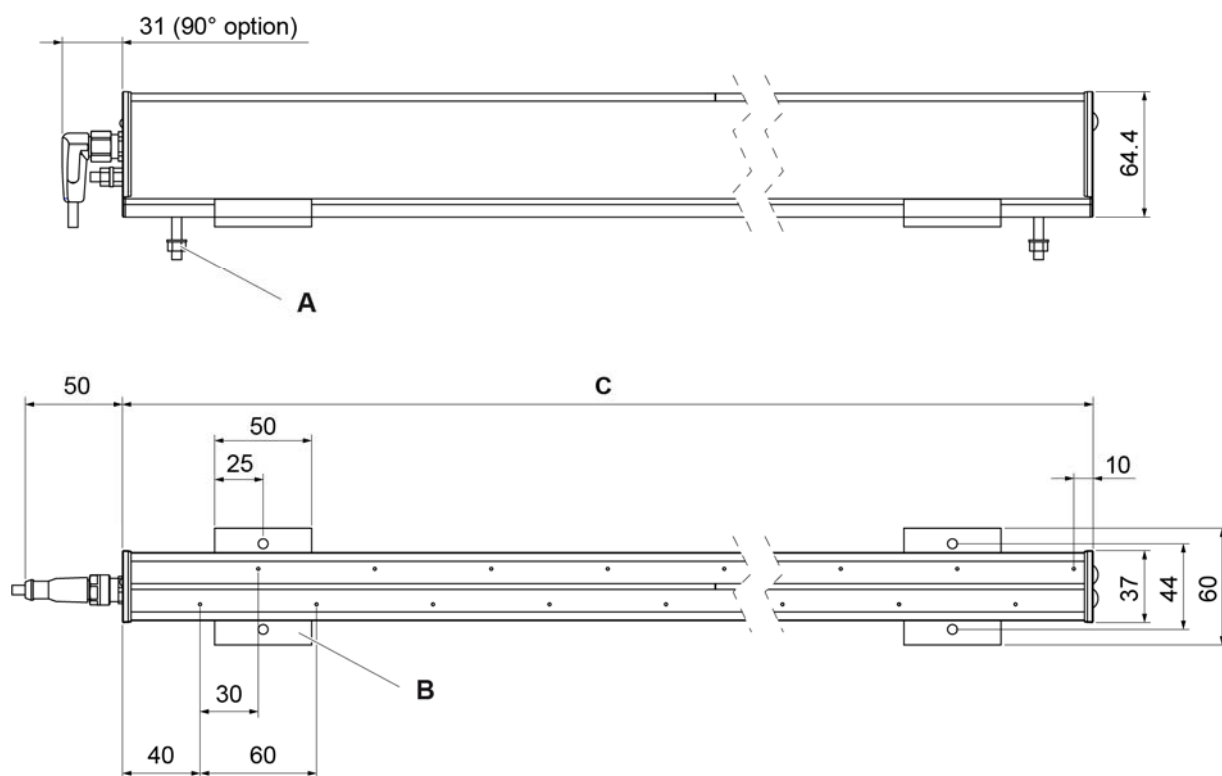

fig. 5:

- A** Mounting option 1 at least 2 attachment screws per m + 1 Pro per additional m
- B** Mounting option 2 Freely slidable GRP brackets (at least 2 per m + 1 Pro per additional m)
- C** GL working width





# Electrical Connection

---

## Connector specification

Bus system connector, M12, 5-pin, easy and flexible adaptation for individual systems via "daisy chain" connection.



*fig. 6: Standard version*

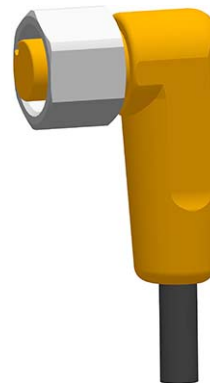

*fig. 7: 90 degree version: Option*

## Description of the Connections

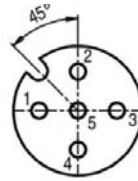

fig. 8: Pin position and number

Pin	Function	Standard Hildebrand cable
1	Error	brown
2	$U_{in}$ 20-28 VDC	white
3	GND	blue
4	CAN H	black
5	CAN L	gray

## Explanation of pin functions

<b>Pin 1</b>	Return signal for clean bar or system error. <ul style="list-style-type: none"> <li>- 24 V = System OK</li> <li>- 0 V = System fault</li> <li>- Must be connected to 24 V power supply via 680 Ohm resistor.</li> </ul>
<b>Pin 2</b>	Supply voltage 20–28 VDC (20 kV < 500 mA)
<b>Pin 3</b>	GND
<b>Pin 4</b>	CAN High
<b>Pin 5</b>	CAN low

### **⚠ WARNING**

#### **Danger of electric shock**

- ▶ Always ground using the ground stud!

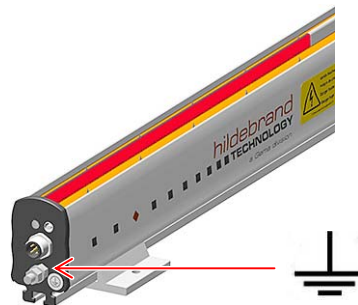

fig. 9: Connection to machine or plant mass / ground

## Use in standalone operation

Standalone operation occurs without the use of a communication interface. For use of an individual charging bar, simply connect the 24 VDC power supply protected by the fuse (for value, refer to “Technical Data”). The system runs according to the factory settings.

### **▲ WARNING**

#### **Explosion hazard**

- ▶ In stand-alone operation, the connection to the power supply of the ionizers must be carried out outside the explosive area (zone) by means of the stand-alone cable to prevent the risk of ignition.



#### **IMPORTANT for system status detection:**

- Machine speed > 0 m/min.                      = 24 VDC ON
- Machine STOPP    = 24 VDC OFF

## Factory settings

HV frequency range to	100 Hz
max. output voltage	20 kV
Operating mode	DCDC

---

## Use of PIN1 output: for clean bar or system error



---

In order to use the error output, PIN 1 must be connected via a 680-Ohm resistor to the 24 V power supply.

---

Beschaltungsschema Error- Ausgang  
Widerstand : 1x / Netzwerk

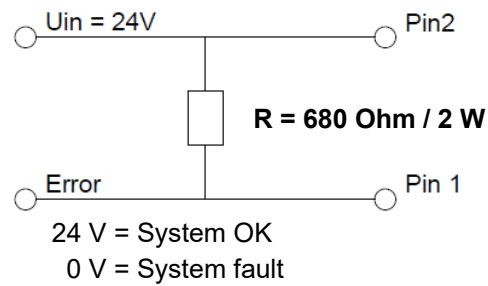

## Overview of local multi-function LED: Functions

	Visual display: Device Status	LED function
1	INITIALIZING	flickering green 50/50 ms
2	STANDBY	blinking green 500/1000 ms
4	ACTIVE	constant green
6	CLEAN BAR WARNING	blinking green yellow 500/500 ms
7	CLEAN BAR ALARM	constant yellow
12	STARTUP	blinking green 200/200 ms
	Visual display: Error/Support	LED function
0	UNKNOWN	off
3	STOPPED	flashing green 50/1000 ms
5	DISCOVERY	color rotation 200 ms
8	PIN AGED	flickering red 50/50 ms
9	TIMEOUT	triple flash red
10	FAILURE	constant Red
11	UNCONFIGURATED	blinking Red 200/200 ms
13	CHECK INSTALLATION	flickering red yellow 50/50 ms

## Description of LED functions

<b>0</b>	<b>Unknown</b>	System not configured or no power supply connected. LED off.
<b>1</b>	<b>Initializing</b>	Initialization in progress. The standard currents are measured. (No external electrostatic fields should be present during this process)
<b>2</b>	<b>Standby</b>	This function is only active within a CANopen network using the iONmaster, iONgate or iONlink. It shows that the charging electrode is waiting for an activation signal from a master device.
<b>3</b>	<b>Stopped</b>	This function is only active within a CANopen network using the iONmaster, iONgate or iONlink. It shows that the charging electrode has been manually disabled by a master device.
<b>4</b>	<b>Active</b>	System is in the correct function mode and high voltage supply is active.
<b>5</b>	<b>Discovery</b>	This function is only active within a CANopen network using the iONmaster, iONgate or iONlink. In this mode, a charge electrode can manually be found within the network by using its NODE-ID / Serial No. as the input at the master device. Discovery mode is automatically reset after 20 minutes.
<b>6</b>	<b>WARNING (contamination)</b>	This mode shows that the contamination of the bar has reached the set warning value. (Factory setting = 40 %) System efficiency has dropped from originally 100 % to 60 %.
<b>7</b>	<b>ALARM (contamination)</b>	This mode shows that the contamination of the bar has reached the set alarm value. (Factory setting = 60 %)

System efficiency has dropped from originally 100 % to 40 %.

8	<b>Worn tips (wear &amp; tear)</b>	<p>This mode displays the emitter pin status. The pin sharpness has reached the set limit value for abrasion of the pins due to wear / age (factory setting = 80 %)</p> <p>The system efficiency has dropped from 100 % to below 80 % without contamination / after the bar has been cleaned.</p>
9	<b>Timeout</b>	<p>The external residual charge sensor cannot not be found. This function is only active when the FEEDBACK mode is activated and an iONsense 4.0 sensor is connected.</p>
10	<b>Failure</b>	<p>This mode shows that the charge system has detected an error and is not functioning. Within a network, the error code can be read using the iONmaster, iONGate or iONlink.</p>
11	<b>Unconfigured</b>	<p>This mode shows that the BUS subscriber has no NODE-ID and no application parameters are saved. This mode only occurs when the NODE-ID has been deleted or the factory settings were not saved.</p>
12	<b>Start up</b>	<p>In this state, the system waits for 1 sec for a "Speed Message" or a CAN "hard-beat". If there is no BUS available, the system automatically switches to the initialization state and activates the charge.</p>
13	<b>Check Installation</b>	<p>This mode shows that the charge electrode has been installed to close to a ground / machine ground.</p>

## Network Operation

iONcharge systems are charging systems with integrated high voltage power supply and micro controller technology. This enables the systems to be connected to a master unit such as a PC or a GateWay. Via the internal CANopen bus, the system can communicate and write as well as read parameters. All components (max. 127 subscribers) are jointly connected to the Hildebrand CAN-Bus with the same rights.

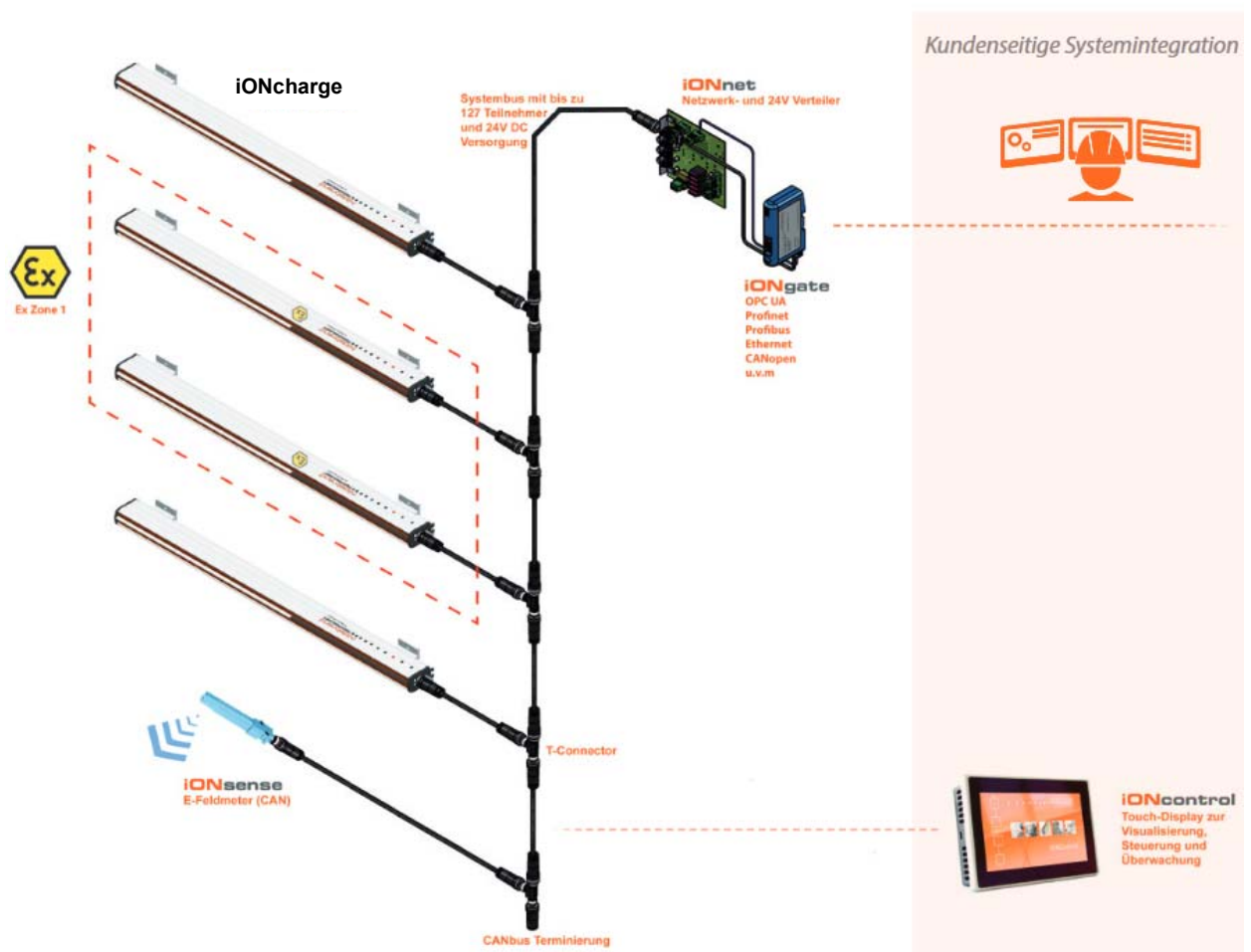

fig. 10: Overview



**Bus cable lengths from the charging bar to the T-connector are always shorter than from T-connector to T-connector.**

- See network layout drawings. 5 m maximum.

For detailed information on the wiring of the individual options, please refer to the drawings attached to this manual.





# Application information

With the iONcharge 4.0 charging system, it is possible to automate and control a wide range of industrial processes through targeted charging. This includes fully automatic roll changes without gluing, blocking and adhesion of materials, improvement of print quality, targeted application of aerosols and coatings, fixation of web materials and much more. As an example, a positive or negative charging electrode is used for the blocking process depending on the substrate and requirement. The charging electrode provides the desired high voltage with the most homogeneous charge distribution over the entire working area. The substrates are perfectly blocked and ready for the next processing steps.

## WARNING

Never use charging systems in flammable or explosive environments if they are not Ex-Certified. Ex-Certified bars have an ATEX Ex label attached to the bar profile.

## ATTENTION

Only for insulating substrate materials!  
Electrostatic bonding is based on insulating substrate material.  
Any metalized or metal substrate cannot be charged and may result in the damage of material as well as damage of the charging system.

## Basic layouts for charging applications

### Example: Attaching to wrap

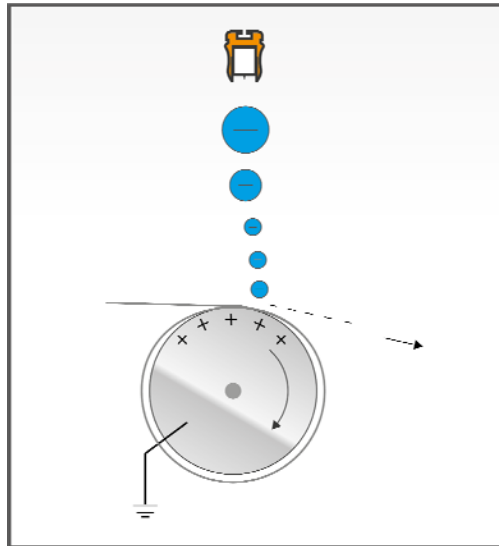

With the help of the charging bar, the material can be tacked to the start or end of the roll without the need for a bonding material. The charging or blocking process can be controlled in time by an external signal or via a field bus.

### Example: Cooling roll adhesion

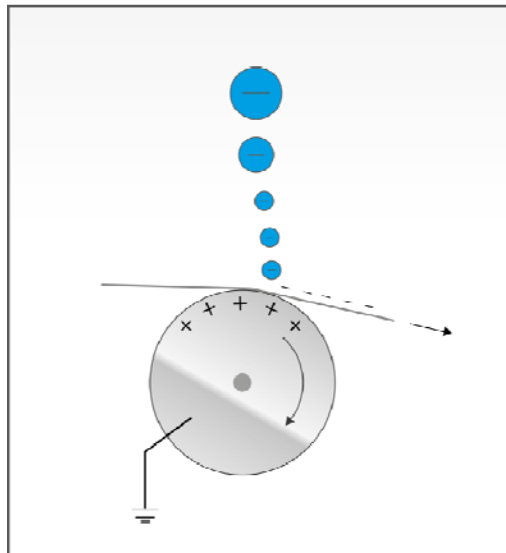

The charging bar is located opposite the grounded cooling roller. As a result of the electric field, the material band will stick to the grounded roller.

## Example: Strand adhesion

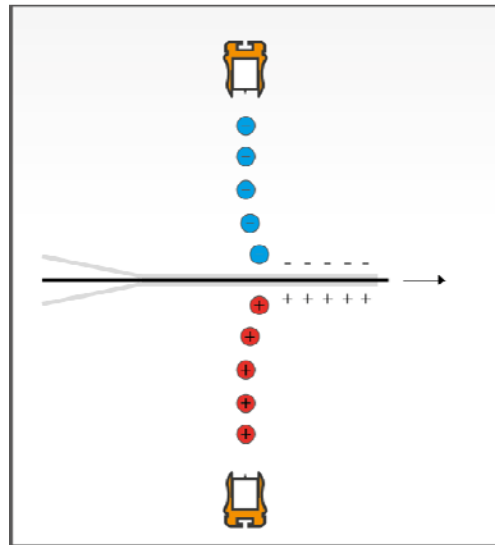

The negative ions of the upper electrode attract the positive ions of the lower electrode, creating maximum strand adhesion between the upper and lower layers.

## Setting the NodeID and the high voltage

The setting is made using the T button:



### ⚠ CAUTION

#### Danger due to electrostatic charge

**People not connected to the ground can be electrostatically charged, which could result in an electric shock if they are touching a metal part.**

- ▶ Before the button is pressed (preferably with a screwdriver), the operator must ensure that he is earthed himself.
- ▶ Touch and hold a grounded metallic machine part, or use a wrist ground strap.
- ▶ The strap must be connected to a grounded metal part or grounding point using a terminal or plug, e.g. a machine part or an grounding point at the workplace.



**In order for the newly set NodeID to be updated, the supply must be interrupted for 3 seconds.**

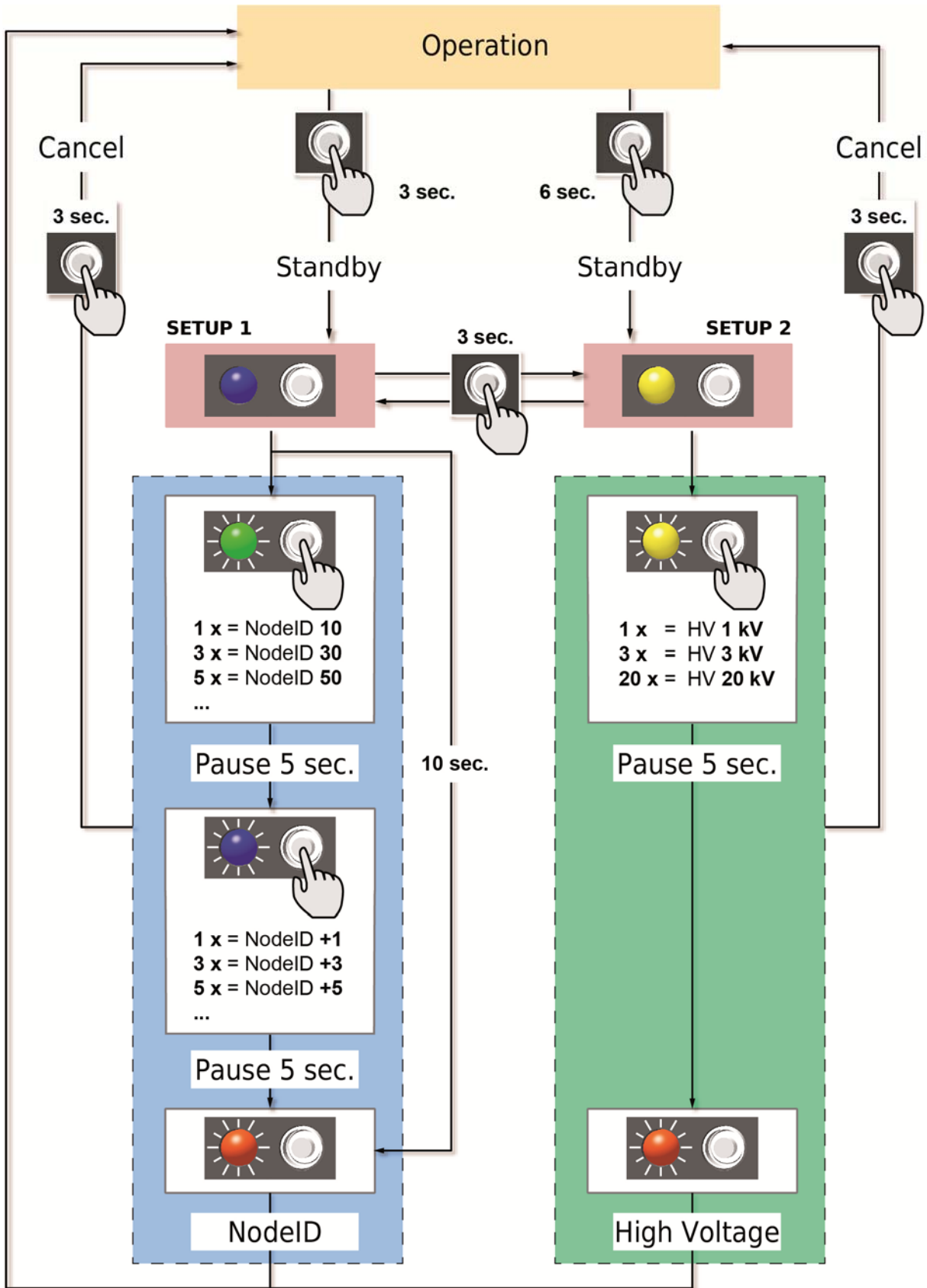

# Technical Data

## Electrical data

### Input

		Value	Min.	Nom.	Max	Unit
Number of contacts		N	5 pin/M12			
Power supply (pin2(+); 3(GND))		$U_{in}$	20	24	28	VDC
Current consumption	20 kV	$I_{in}$	40	100	300	mA

### Output

		Value	Min.	Nom.	Max	Unit
Voltage	20 kV	$U_{out}$	0	$\pm 20$	$\pm 20$	kV
Current of all emitter tips	20 kV	$I_{out}$	0		$\pm 500$	$\mu A$
Contact current (1 emitter tip)	20 kV	$I_b$		60		$\mu A$
Protective resistor	20 kV	$R_{out}$		300		$M\Omega$
Grid	20 kV	$I_{pitch}$		30	30	mm
Error Pin (Pin 1)	Open collector (OR-circuit) max. 28 V 100 mA					

### General

		Value	Min.	Nom.	Max	Unit
Communication	CAN Open					
Bus clock				125		kbit/s
Termination (external and on both sides)	$R_{term.}$			120		$\Omega$
Ground connection terminal	with M5 screw and nuts at machine ground					

## Mechanical data

	Value	Min.	Nom.	Max	Unit
Width	w		35		mm
Height	h		64		mm
Working width 20 kV	GL	320		4460	mm
Weight	m		2.7		kg/m
Attachment rail	M5 T-slot or iONclip (min. 1/m)				

## Ambient conditions

	Value	Min.	Nom.	Max	Unit
Temperature	TAmb	5	25	40	°C
Humidity/ non-condensing	rF		35	80	%rel. F.
Protection class acc. to DIN 60529	IP68 (M12 connector tightened with tool)				
Fuse in primary circuit (provided by the customer)	F	Stand-alone 500 mA T depending on power consumption of the devices +10% (max. 4 A/ phase)			mA

## Optical display/ device status/ error

Optical display/ device status/ error	#	LED (connection side electrode)	Error-pin
UNKNOWN	0	off	off
INITIALIZING	1	flickering green 50/50 ms	off
Standby	2	blinking green 500/1000 ms	off
STOPPED	3	flashing green 50/1000 ms	off
active	4	constant green	off
DISCOVERY	5	color rotation 200 ms	off
Clean Bar Warning	6	blinking green yellow 500/500 ms	off
Clean Bar Alarm	7	constant yellow	active
PIN AGED	8	flickering red 50/50 ms	active
TIMEOUT	9	triple flash red	active
FAILURE	10	constant Red	active
UNCONFIGURATED	11	blinking Red 200/200 ms	active
STARTUP	12	blinking green 200/200 ms	off
Check Installation	13	flickering red yellow 50/50 ms	active



---

## Technical Service

**Gema Switzerland GmbH**

Mövenstrasse 17

9015 St.Gallen

Switzerland

Phone: +41-71-313 83 00

Fax: +41-71-313 83 83

[info@hildebrand-technology.com](mailto:info@hildebrand-technology.com)**Global sales and service network**[www.gemapowdercoating.com](http://www.gemapowdercoating.com)[www.hildebrand-technology.com](http://www.hildebrand-technology.com)